

Reference Guide to Automatic Processing of INDUSTREX Films

Recommended Chemicals and Mixing Instructions

Manual Mixing:

- Measure water for correct dilution.
- Add replenisher concentrate and mix using a separate paddle for Developer and Fixer to avoid contamination.
- Mix only enough replenisher to last a week to assure fresh chemicals.

IMPORTANT: use floating lid for developer replenisher tank to prevent oxidation and maximize solution life.

	Dilution Concentrate + H ₂ O	Replenishment Rate	pH Working Strength	Specific Gravity Working Strength	To Make Working Strength Solution
Developer					
Use INDUSTREX Single Part Developer and Replenisher.	1 + 3	665mL/m ² (e.g., 100 mL per 14 x 17 inch sheet)	10.40 +/- 0.10 (25° C, 77° F)	1.072 +/- 0.005 (20° C, 68° F)	<p>15 L 5-25 °C + 3 L = 20 L 1 + 3 H₂O SG 1.072 ± 0.005</p>
Material No. 5315288					
Fixer					
Use INDUSTREX LO Fixer and Replenisher.	1 + 3	1200mL/m ² (e.g., 180mL per 14 x 17 inch sheet)	4.90 +/- 0.10 (25° C, 77° F)	1.084 +/- 0.005 (20° C, 68° F)	<p>15 L 5-25 °C + 3 L = 20 L 1 + 3 H₂O SG 1.084 ± 0.005</p>
Material No. 5159082					

Chemical Mixers

- Proper templates that match the bottles should be used.
- Thorough mixing is necessary after each addition.
- Ideally, the mixer should have a floating lid to protect the solutions from oxidation.
- The concentrates should be examined to be certain there is no premature oxidation due to excessive handling.
- The manufacturer's recommended water-mixing temperature should be observed.
- A new mix of developer and/or fixer should only be made when indicated by the solution level in the mixer.
- To aid in verifying that the chemistry is acceptable, the pH and the specific gravity can be measured. It is important to make these measurements at the recommended temperatures for the instrument used. (see above)
- The processor should be turned off when mixing.

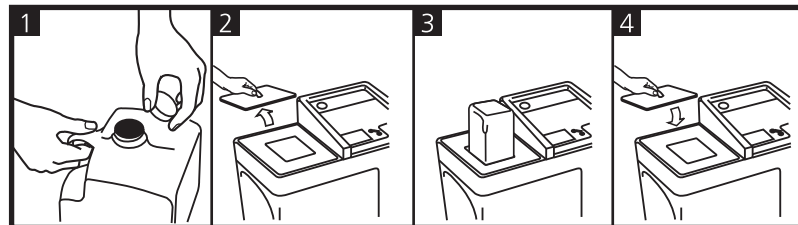

Developer Tank Sizes/Starter Volume

INDUSTREX Processor Model	Developer Tank Volume (L)	Starter Amount (31 ml/L) Material No. 835 1413
M43	13.5	418.5
M37	6.5	201.5
M37 Plus	7.5	232.5

Developer Immersion Time and Temperature

INDUSTREX Processor Model	Recommended Cycle Speed (cm/min)	Developer Immersion Time (Sec)	Cycle Time (Dry-to-Dry) (Min)	Developer Temperature (C)
M43	39	100	8	26 C (78.8 F)
M37/M37 Plus	22	110	7	28 C (82.4 F)

Calibrating Replenishment Pumps and Checking Replenishment Rates

NOTE: Use qualified service personnel and refer to manual for each specific model, to perform the following procedures.

INDUSTREX Processor Model	Replenishment Pump Calibration Method	Setting Replenishment Rates
M43/M37/M37 Plus	A	B

Calibration Method

A: Use the control panel/display and the programming menu to select Manual Replenishment Cycle and request 400 ml. of developer replenisher and verify it is delivered by the pump. (Fill a graduated cylinder with 500 ml of replenisher and insert the replenishment intake hose into the graduated cylinder or collect the overflow). The pump can be mechanically adjusted to deliver the amount requested as necessary. It may take several measurements and adjustments to match the pump to the amount requested. Repeat for fixer.

B: Use the control panel/display panel and the programming menu to select Setup Mode, Program, Modify and adjust developer replenishment rate per to 665 ml and fixer replenishment rate to 1200 ml.

Site Specification and Installation of Automated Processors

NOTE: Refer to the manual for the specific equipment and use.

Access:

- Service access of 50 cm. around the processor.

Water:

- Filtered water supply of proper water temperature, pressure and flow. A mixing valve may be necessary.
- A sink large enough to accommodate cleaning processing racks a minimum of 50 cm wide.
- Hose that can reach the processor for cleaning.

Drain:

- Minimum 7.6 cm diameter drain hose or line, free of bends and have a constant decline to the drain.
- Height from floor: Top of the drain or drain containers must be lower than the bottom of the processor.
- A floor or wall drain may be used which should include an anti-siphon system.
- The drain must be ventilated and do not use brass or copper in the drain lines.

Room Ventilation:

- The processing area should have 10 air changes per hour, 24 hours per day, 7 days per week. For example: a 3 x 3 x 3 m room has a volume of 27 cubic meters, so the ventilation system should supply the room with 270 cubic meters of fresh air per hour.
- For through-the-wall installations, the air pressure in the darkroom area where the processor is located must be of slightly higher pressure than the surrounding rooms to assure that the airflow through the processor is in the correct direction.

Processor Exhaust:

- Dedicated exhaust that provides proper Negative Static Pressure (see table below), 24 hours per day, 7 days a week, connected to the processor using the proper size dryer duct hose with adjustable air gap. A supplemental Exhaust Fan can be purchased if an adequate exhaust system is not available at the site. The processor can not be vented into the room where the processor resides.
- Use of a Dwyer Air Meter TL-2431 or equivalent to measure exhaust.

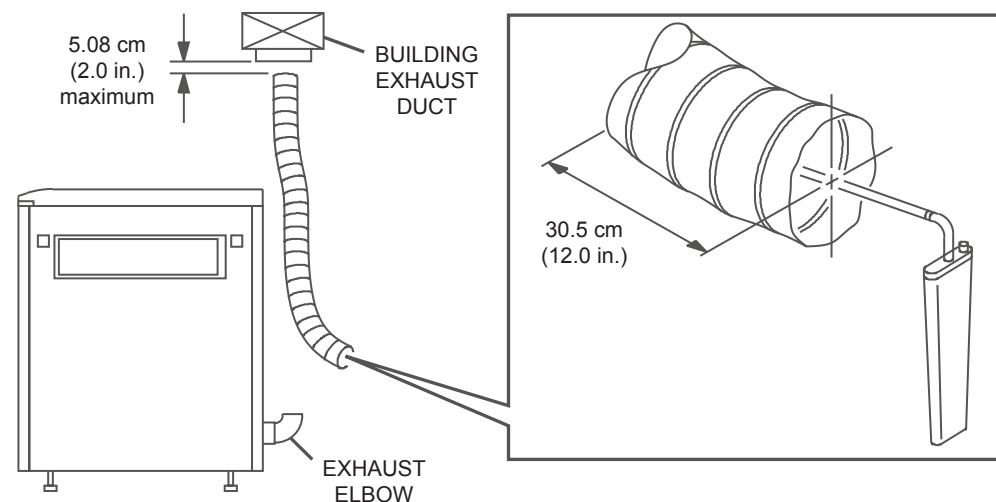

Dryer Exhaust Duct Diameter (cm)	Negative Static Pressure (mm of water)
7.6 cm	0.76 - 2.54 mm
10.2 cm	0.25 - 1.02 mm

Start-Up, Shutdown, Cleaning and Maintenance

Start-Up:

- Check the wash tank drains are closed.
- Turn on water supply.
- Close the cover of the processor.
- Switch on the processor and check for any errors.
- Check replenishment tank levels.
- Check waste tank levels.
- Top off processing tanks with chemistry.
- Before starting production place 2 full-size cleaning sheets into the processor, preferably INDUSTREX Roller Transport Cleanup Film, Cat No. 122 4310

Shut-Down:

- Power off the processor.
- Turn off the water supply.
- Remove the top cover.
- Drain the water.
- Spray down rollers and gears above solution level with warm water using a water spray bottle.
- Place the top cover back on the processor at an angle for venting purposes.
- Check the levels in the waste chemical collection containers.

Weekly Check:

- Check and clean the wash rack rollers/water tank ensuring roller and tank surfaces are free from deposits and algae.
- Check and clean all crossover rollers.
- Check water supply, filters/water drain.
- Check the replenishment (see "Calibrating Replenishment Pumps and Checking Replenishment Rates").
- Recommend the customer to keep a "service book" and to write down everything related to the processor. (Dates when chemicals/filters changed, cleaning/service issues, and problems).

Periodic Maintenance Advice for Service Technicians:

Technical checks every 3 to 4 months to be made by a qualified service technician.

- Switch off machine and unplug from power.
- Drain all tanks.
- Remove the racks for cleaning. Handle carefully, so as not to damage rollers and rack components.
- When cleaning the developer and fixer tank and racks, carefully remove chemical deposits and inspect rollers. Do not use abrasive materials to clean rollers, racks or guide shoes.
- Drain and fill all tanks with fresh clean water and switch on the unit.
- Connect the replenishment system with water and start the replenishment pumps and verify proper calibration and replenishment rates. (See "Calibrating Replenishment Pumps and Checking Replenishment Rates").
- Drain all 3 tanks and refill with clean water. Allow Recirculation for 10 minutes and then drain completely.
- Replace developer filter.
- When a Chiller System is in use check the level of cooling agent and top up when necessary.
- Measure and adjust processor ventilation (see above).

Note: Refer to the manual for the specific equipment for the complete and detailed periodic maintenance schedule and instructions.

Process Quality Control Tools:

Roller Transport Cleanup Film Cat No. 122 4310

- Removes precipitates, dirt, and other materials deposited.
- Use each morning or after an extended period of idle time (typically more than four hours).
- Useful to control artifact called delay streaks.

INDUSTREX Process Control Strips Cat No. 526 1326

- Process Control Strips are exposed onto INDUSTREX MX125 Film. This box of 25 pre-exposed 6 x 24 cm control strips has READY-PACK II packaging and contains 25 pouches.

INDUSTREX Test Film Cat No. 508 5436

- INDUSTREX Test Film is useful in identifying and correcting processing artifacts prior to processing important radiographs.
- Shelf-life 12 months from pre-exposure date.
- Uniformly pre-exposed within Carestream to an average optical density of 1.9

Exposure Film Factor (R)

Film Type	Density Desired			
	2.0	2.5	3.0	3.5
HS800	0.8	1.1	1.3	1.6
AA400	1.3	1.7	2.0	2.6
T200	2.2	2.8	3.4	4.0
MX125	4.4	4.8	5.3	5.9
M100	7.6	8.0	8.6	9.1

Reference Guide to the Manual Processing of INDUSTREX Films

Recommended Chemicals

	Dilution Concentrate + H ₂ O	Replenishment Rate	pH Working Strength	Specific Gravity Working Strength	To Make Working Strength Solution
Developer					
Use INDUSTREX Manual Developer and INDUSTREX Manual Developer Replenisher.	1 + 3	665mL/m ² (e.g., 100 mL per 14 x 17 inch sheet)	10.55 +/- 0.10 (25° C, 77° F)	1.078 +/- 0.005 (20° C, 68° F)	
Stop Bath					
Use INDUSTREX Manual Stop Bath. This stop bath rapidly halts development, preventing most spotting and streaking and prolongs the life of the fixing bath. This odorless stop bath features an indicator that changes color (from orange-yellow to magenta-red) at pH 5.2 to alert the user of declining activity, so that the solution can be changed or additional concentrate added.	1 + 19	No replenishment required. Add water to compensate for carryover and evaporation. Change out the solution when a color change occurs, or add more concentrate.	2.20 +/- 0.10 (25° C, 77° F)	— —	
Fixer					
Use INDUSTREX Manual Fixer and INDUSTREX Manual Fixer Replenisher.	1 + 3	1200mL/m ² (e.g., 180mL per 14 x 17 inch sheet) It may be necessary to discard some used solution before adding the proper volume of replenisher.	5.80 +/- 0.10 (25° C, 77° F)	1.095 +/- 0.005 (20° C, 68° F)	
Final Rinse					
Use INDUSTREX Manual Rinse Solution. This solution is a wetting agent that effectively reduces water spots and drying marks.	1 + 19	No replenishment required. Add water to compensate for carryover and evaporation. Change out the solution when other solutions are changed.	— —	— —	

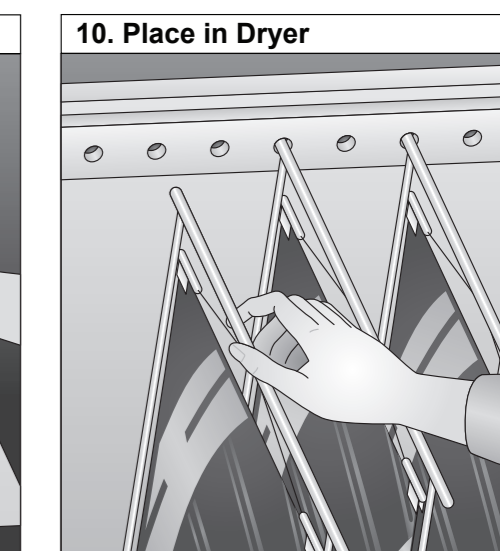
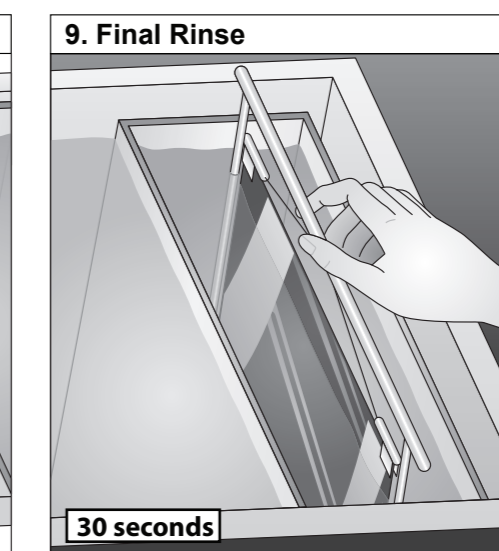
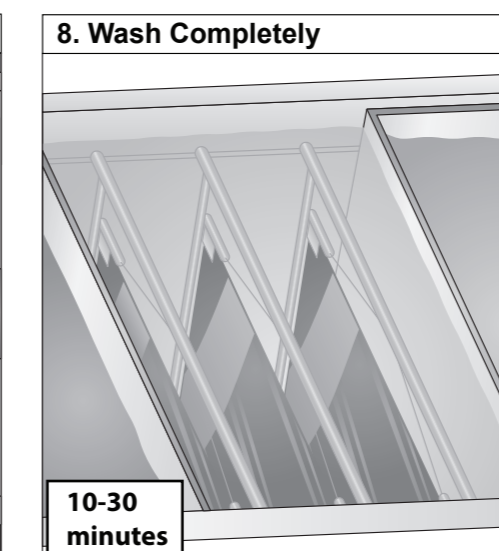
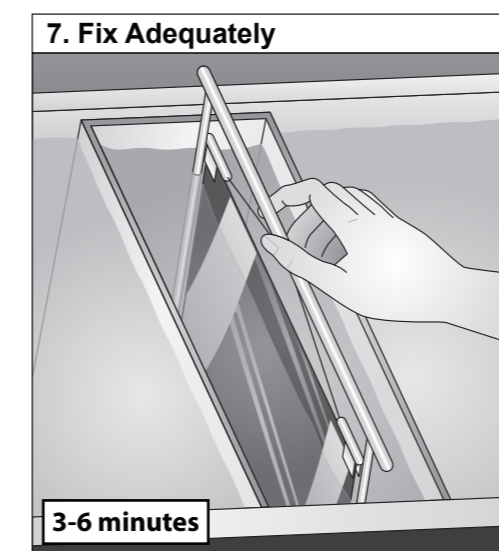
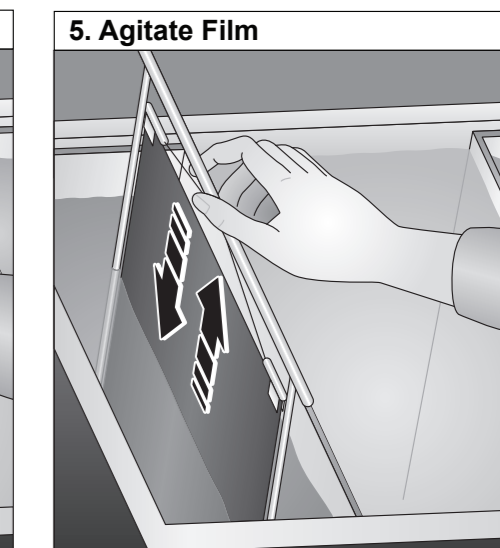
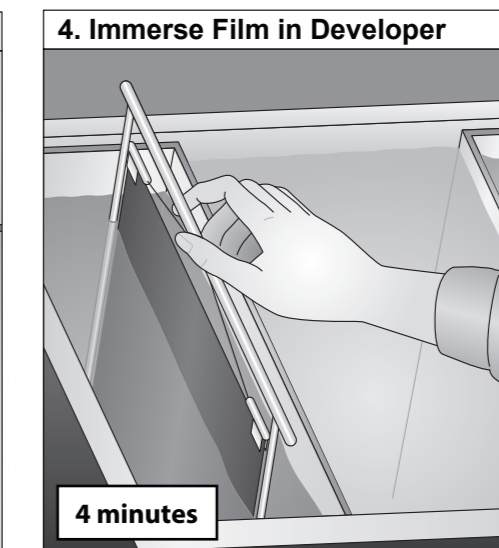
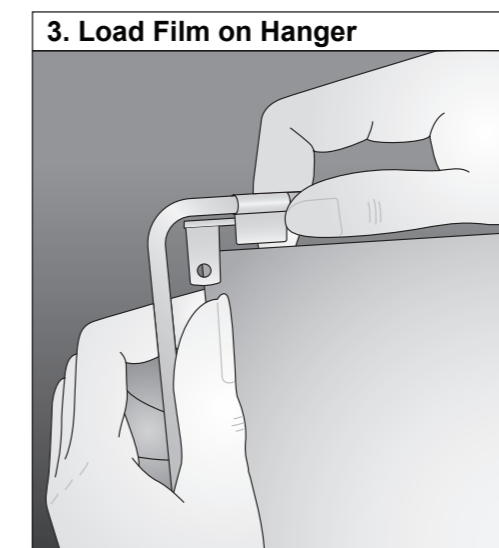
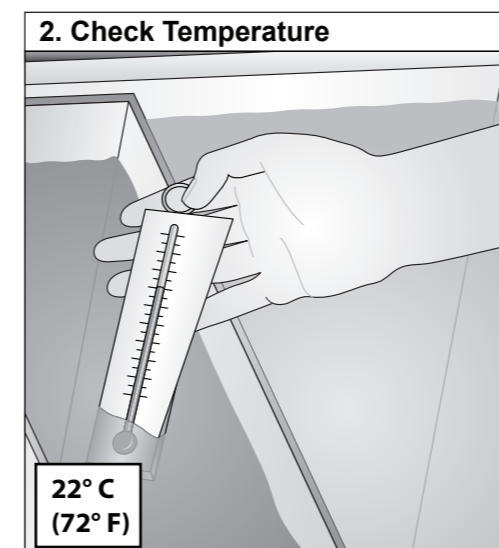
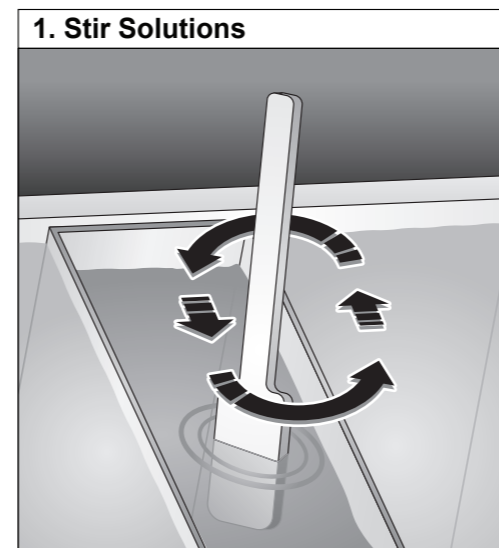

Manual Processing Cycle

	Developer	Stop Bath	Fixer	Wash	Rinse Solution
Time/Temperature	5 minutes - 20°C (68°F) 4 minutes - 22°C (72°F)* 3 minutes - 24°C (75°F) 2 minutes - 26°C (79°F)	30 seconds	3 to 6 minutes or twice the time to clear film	10 to 30 minutes in running water (8 volume changes per hour)	30 seconds
Notes	<p>Important: Agitate 15 seconds at immersion, then intermittent - 5 seconds every 30 seconds.</p> <p>Use floating covers on the developer tank to reduce oxidation and evaporation; store developer replenisher in a closed airtight container.</p> <p>Fill the developer tank to its original level each day (topping off) with developer replenisher solution.</p>	<p>Important: PULL AND PLUNGE FILM DIRECTLY FROM DEVELOPER INTO STOP BATH. DO NOT ALLOW EXCESS DEVELOPER TO DRAIN BACK INTO DEVELOPER TANK.</p> <p>Continuous moderate agitation.</p> <p>Fill the stop bath tank to its original level each day (topping off) with water.</p>	<p>Important: Agitate the film for 5 seconds every 30 seconds.</p> <p>Fill the fixer tank to its original level each day (topping off) with fixer replenisher solution.</p>		<p>Fill the final rinse tank to its original level each day (topping off) with water.</p>
	Stir solutions after each addition.				
	Discard solutions after adding two tank volumes of replenisher to the tank, or at least once per month, and then refill with fresh solution.				

* Recommended

Ensuring Process Quality

Test kits may be used to ensure archival characteristics for processed radiographs. These kits will indicate whether film has been adequately washed and when a fixing bath should be discarded. Information on the Residual Thiosulfate Test, Residual Silver Test, and the Fixer Test Solution can be found on the CARESTREAM website and in publication TI-6K7080, *INDUSTREX Films*.

Exposure Film Factor (R)

Film Type	Density Desired			
	2.0	2.5	3.0	3.5
HS800	0.8	1.1	1.3	1.6
AA400	1.3	1.7	2.0	2.6
T200	2.2	2.8	3.4	4.0
MX125	4.4	4.8	5.3	5.9
M100	7.6	8.0	8.6	9.1